

V_{WM} = 5V, 3pF ESD Protection Array

FEATURES

- Meet IEC61000-4-2(ESD) ±15kV(air) , ±8kV(contact)
- Working Voltage: 5V
- RoHS Compliant
- Halogen-free according to IEC 61249-2-21

APPLICATIONS

- Digital Visual Interface(DVI)
- 10/100/1000 Ethernet
- Projection TV Monitors and Flat Panel Displays

MECHANICAL DATA

- Case: SOT-363
- Molding compound meets UL 94 V-0 flammability rating
- Moisture sensitivity level: level 1, per J-STD-020
- Terminal: Matte tin plated leads, solderable per J-STD-002
- Meet JESD 201 class 1A whisker test
- Polarity: As marked
- Weight: 6.99mg (approximately)

KEY PARAMETERS		
PARAMETER	VALUE	UNIT
P _{PPSM}	150	W
I _{PP}	6	A
V _{WM}	5	V
V _(BR) at I _R = 1mA	6	V
V _C at I _{PP} = 6A	25	V
Package	SOT-363	
Configuration	Single die	

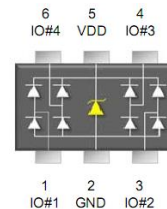
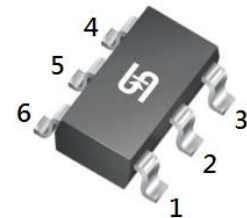

ABSOLUTE MAXIMUM RATINGS (T _A = 25°C unless otherwise noted)			
PARAMETER	SYMBOL	TESD5V0V4UCU6	UNIT
Marking code on the device		F54	
Rated random recurring peak Impulse power dissipation (tp = 8/20µs waveform)	P _{PPSM}	150	W
Peak impulse current (tp = 8/20µs waveform)	I _{PP}	6	A
ESD per IEC 61000-4-2 (Air)	V _{ESD}	±15	kV
ESD per IEC 61000-4-2 (Contact)		±8	
Junction temperature range	T _J	-55 to +150	°C
Storage temperature range	T _{STG}	-55 to +150	°C

ELECTRICAL SPECIFICATIONS ($T_A = 25^\circ\text{C}$ unless otherwise noted)						
PARAMETER	CONDITIONS	SYMBOL	MIN	TYP	MAX	UNIT
Reverse breakdown voltage ⁽¹⁾	$I_R = 1 \text{ mA}$	$V_{(BR)}$	6	-	-	V
Rated working standoff voltage		V_{WM}	-	-	5	V
Reverse current ⁽¹⁾	$V_R = 5 \text{ V}$	I_R	-	-	3	μA
Clamping voltage ⁽²⁾	$I_{PP} = 1 \text{ A}$ (any pin to pin 2)	V_C	-	-	15	V
Clamping voltage ⁽²⁾	$I_{PP} = 6 \text{ A}$ (any pin to pin 2)	V_C	-	-	25	V
Junction capacitance	1MHz, $V_R = 0\text{V}$ (between I/O pins)	C_J	-	-	1.5	pF
Junction capacitance	1MHz, $V_R = 0\text{V}$ (any I/O pin to GND)	C_J	-	-	3	pF

Notes:

1. Pulse test with PW = 30ms
2. $t_p = 8/20\mu\text{s}$ waveform

ORDERING INFORMATION		
ORDERING CODE	PACKAGE	PACKING
TESD5V0V4UCU6 RFG	SOT-363	3K / 7" Reel

CHARACTERISTICS CURVES

($T_A = 25^\circ\text{C}$ unless otherwise noted)

Fig.1 8/20 μs pulse waveform according to IEC 61000-4-5

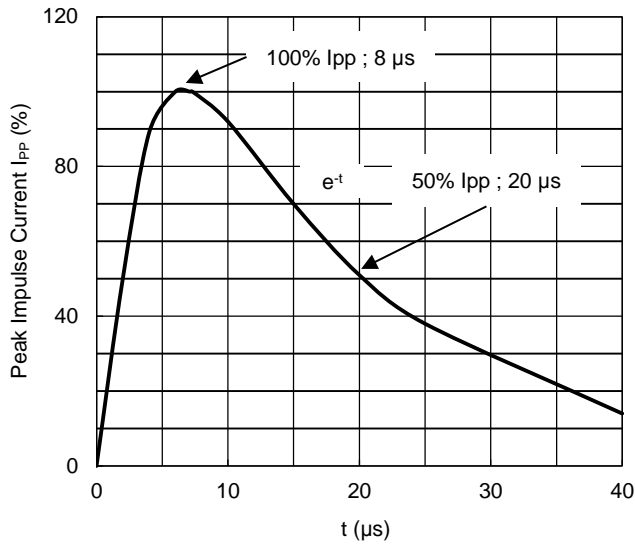

Fig.2 ESD pulse waveform according to IEC 6100-4-2

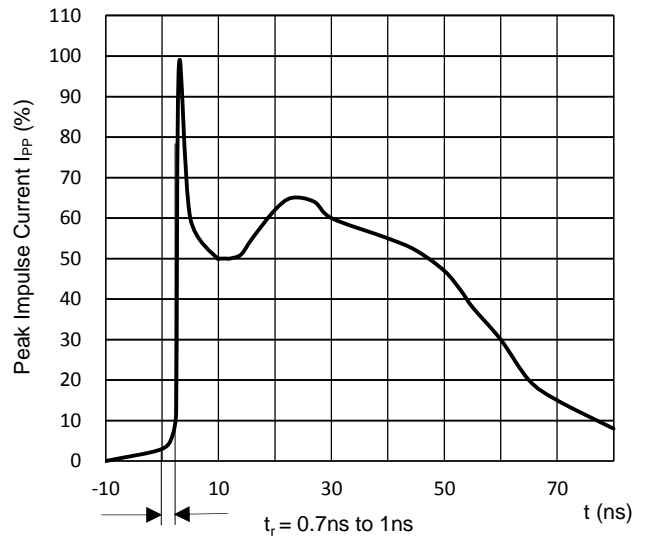

Fig.3 TLP I-V Curve

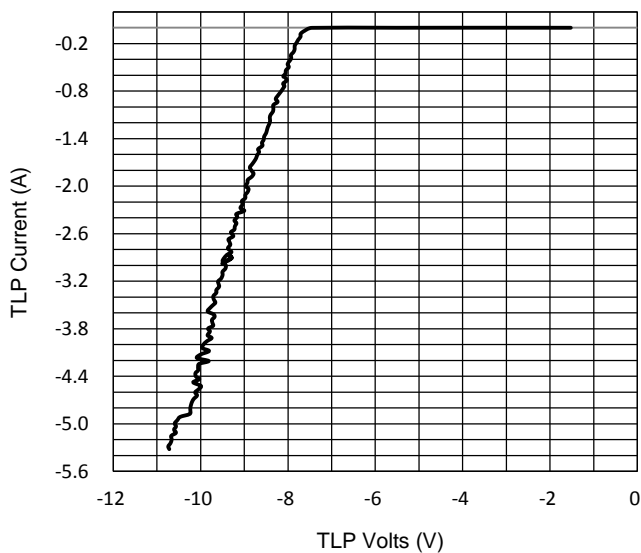
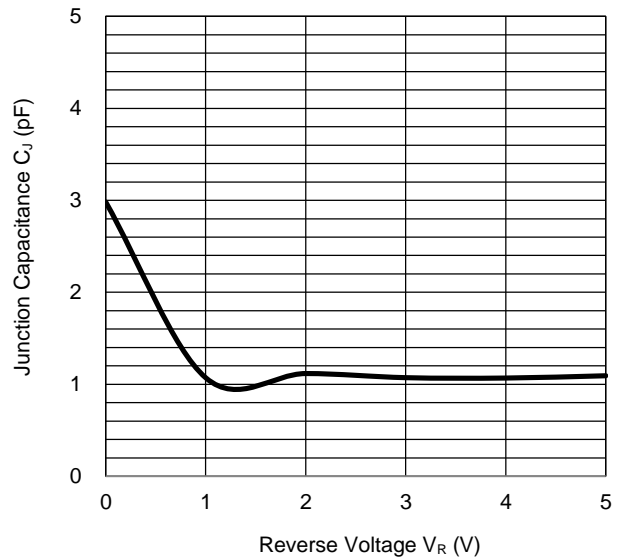

Fig.4 Typical Junction Capacitance (any I/O pin to GND)



CHARACTERISTICS CURVES

($T_A = 25^\circ\text{C}$ unless otherwise noted)

**Fig.5 Typical Junction Capacitance
(between I/O pins)**

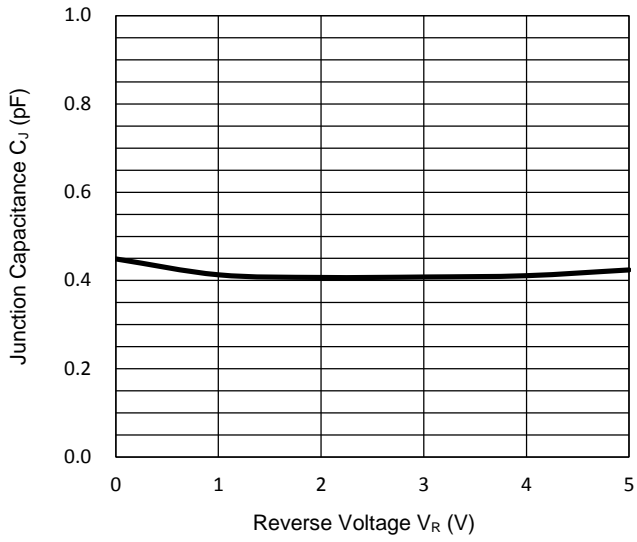

PACKAGE OUTLINE DIMENSIONS

SOT-363

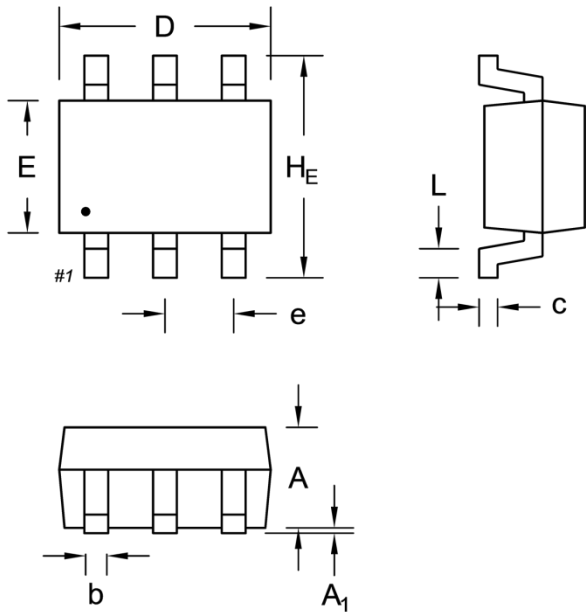

DIM.	Unit (mm)		Unit (inch)	
	Min.	Max.	Min.	Max.
A	0.90	1.00	0.035	0.039
A ₁	0.00	0.10	0.000	0.004
b	0.15	0.30	0.006	0.012
c	0.10	0.25	0.004	0.010
D	1.80	2.20	0.071	0.087
E	1.15	1.35	0.045	0.053
H _E	2.00	2.20	0.079	0.087
e	0.65 (Ref.)		0.026 (Ref.)	
L	0.15	0.40	0.006	0.016

SUGGESTED PAD LAYOUT

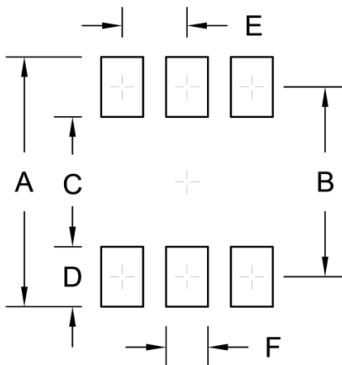

Symbol	Unit (mm)	Unit (inch)
A	2.50	0.098
B	1.90	0.075
C	1.30	0.051
D	0.60	0.024
E	0.65	0.026
F	0.42	0.017

Notes:

This recommended land pattern is for reference purposes only. Please consult your manufacturing group to ensure your PCB design guidelines are met.

MARKING DIAGRAM

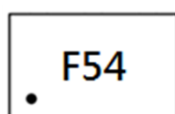

F54 = Marking Code

Notice

Specifications of the products displayed herein are subject to change without notice. TSC or anyone on its behalf, assumes no responsibility or liability for any errors or inaccuracies.

Purchasers are solely responsible for the choice, selection, and use of TSC products and TSC assumes no liability for application assistance or the design of Purchasers' products.

Information contained herein is intended to provide a product description only. No license, express or implied, to any intellectual property rights is granted by this document. Except as provided in TSC's terms and conditions of sale for such products, TSC assumes no liability whatsoever, and disclaims any express or implied warranty, relating to sale and/or use of TSC products including liability or warranties relating to fitness for a particular purpose, merchantability, or infringement of any patent, copyright, or other intellectual property right.

The products shown herein are not designed for use in medical, life-saving, or life-sustaining applications. Customers using or selling these products for use in such applications do so at their own risk and agree to fully indemnify TSC for any damages resulting from such improper use or sale.